

This article was downloaded by: [*Politecnico di Torino*]

On: 12 October 2010

Access details: Access Details: [*subscription number 918546944*]

Publisher *Taylor & Francis*

Informa Ltd Registered in England and Wales Registered Number: 1072954 Registered office: Mortimer House, 37-41 Mortimer Street, London W1T 3JH, UK

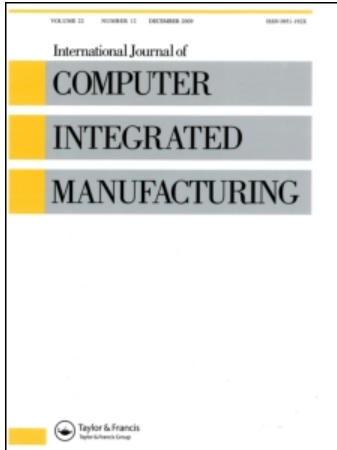

International Journal of Computer Integrated Manufacturing

Publication details, including instructions for authors and subscription information:

<http://www.informaworld.com/smpp/title~content=t713804665>

Control charts for the on-line diagnostics of CMM performances

Fiorenzo Franceschini; Luca Settineri

To cite this Article Franceschini, Fiorenzo and Settineri, Luca(2000) 'Control charts for the on-line diagnostics of CMM performances', International Journal of Computer Integrated Manufacturing, 13: 2, 148 — 156

To link to this Article: DOI: 10.1080/095119200129993

URL: <http://dx.doi.org/10.1080/095119200129993>

PLEASE SCROLL DOWN FOR ARTICLE

Full terms and conditions of use: <http://www.informaworld.com/terms-and-conditions-of-access.pdf>

This article may be used for research, teaching and private study purposes. Any substantial or systematic reproduction, re-distribution, re-selling, loan or sub-licensing, systematic supply or distribution in any form to anyone is expressly forbidden.

The publisher does not give any warranty express or implied or make any representation that the contents will be complete or accurate or up to date. The accuracy of any instructions, formulae and drug doses should be independently verified with primary sources. The publisher shall not be liable for any loss, actions, claims, proceedings, demand or costs or damages whatsoever or howsoever caused arising directly or indirectly in connection with or arising out of the use of this material.



Control charts for the on-line diagnostics of CMM performances

FIorenzo FRANCESCHINI and LUCA SETTINERI

Abstract. The quality of a production process is increasing its dependence on both the manufacturing technology, and the production control. In most applications controls are operated by relying on intelligent instrumentation to ‘automatically’ perform the programmed checks. However, the performance systems that verify the product’s quality can deteriorate, as can the production process. This paper presents a method for the on-line verification of the performance of a coordinate measuring machine (CMM) using statistically based control charts. The method is automated and performed on-line during a normal measurement cycle. Some experimental results are then presented and discussed.

1. Introduction

Coordinate measuring machines (CMMs) are tools that are able to carry out dimensional measurements, and to verify the deviation from geometric regularity on objects that can have a very complex shape. They have their own length standards, which allow obtaining traceability to the metre.

CMMs are able to operate in a completely automatic way. Their main characteristics are programmability and flexibility. These properties allow for advantageous introduction in today’s non-assisted manufacturing cells, with the purpose of carrying out on-line dimensional checks.

Because CMMs are structurally and functionally complex instruments, several different causes can affect their behaviour and the stability of their metrological characteristics over time (Busch *et al.* 1985, CMMA 1989, ISO-10012 1992, ISO-10360 1995).

The possibility of an on-line evaluation of the decay of these characteristics, either due to variations of the environmental factors, or to the deterioration of one of the subsystems that constitute the machine, is an activity of significant interest for the user. It would allow timely correction of the production or measurement process, restoring ‘normal’ conditions, limiting scraps and low-quality production.

A tangible sign of the interest shown in these problems is the large number of relevant international norms that have been issued (AFNOR 1986, ANSI 1990, BSI-6808 1987, CMMA 1989, ISO-10360 1995).

In this paper we present a method, based on the use of control charts, that is able to give useful indications of CMM performances over time. This method can be used as a diagnostic tool to identify possible spurious behaviour due to a number of causes (Franceschini *et al.* 1994).

Since it does not make use of additional instrumentation, the method is different from the normal periodic tests performed off-line through external artefacts (Knapp *et al.* 1991, Belforte *et al.* 1987). The only data used are those produced by the CMM itself during the normal measurement cycles. The method does not require any substantial increase to the workload of the CMM (Alexander *et al.* 1993, Pau 1981, Franceschini and Luisoni 1995). It can be automated without difficulty and performed on-line during a normal measurement cycle.

In the final section of the paper some experimental results are reported.

2. The frequency of the performances control

Among the most important criteria to evaluate a method for the verification of the performances of a

Authors: Fiorenzo Franceschini and Luca Settineri, Politecnico di Torino, Dipartimento di Sistemi di Produzione ed Economia dell’Azienda, Corso Duca degli Abruzzi, 24, 10129 Torino, e-mail: fiorenzo@athena.polito.it

CMM, the following should be mentioned: the time required, the cost and the complexity of the equipment, and the training level and qualification of the operators.

Usually when the quality of information made available by a specific verification method increases, the time required by the execution of the test, the complexity of the equipment used, and furthermore the needed capabilities of the operator increase as well. So we can range from very rapid tests, but with low information density (like go–not go tests), to the complete calibration of the CMM, which can require some days.

The complexity of the verification of CMM performances implies the search for a compromise between the wish to increase the control frequency (prevention of anomaly situations) and the necessity of spacing out over time for cost reasons.

Detecting on-line a possible decay of CMM performances then becomes extremely useful for the user. A first consequence of such an approach is the possibility to indicate the need for a more accurate test or even for a complete calibration only when this is really necessary. The second aspect concerns the ‘guarantee’ that the dimensions of the measured part are really those declared by the instrument.

On the opposite, the periodic verifications allow the detection of a possible damage-state only at the moment in which they are carried out. They do not allow the establishment of the instant at which such damage occurred, nor the causes (Raz and Ladany 1992, Franceschini and Luisoni 1995).

It is opportune to remark that a CMM can typically be subject to three types of verification (ISO 10360 1995):

- (a) the initial verification or acceptance test (the acceptance test is normally long, complex and expensive)
- (b) the periodic verifications (such verifications must be brief, simple to perform and low-cost)
- (c) the irregular/occasional controls.

The typical common elements of such verifications are: the use of more or less complex and costly artefacts, the use of experienced and qualified personnel, and the need to operate off-line when the machine does not work.

Therefore, there is interest in a method that, placing side by side the above verification strategies, is able to automatically display to the operator the occurrence of decay in the machine performances, or in the environment where the CMM works.

3. The proposed method

The on-line control of the metrological performance of a CMM has as its main goal the detection of their possible decay caused, for instance, by variations of environmental conditions or by the degradation of some machine subsystem.

The effect of the degradation of the machine is the production of non-reliable measurements.

How to become conscious that a measurement has been produced by a damaged machine? If this is possible, how to develop a test able to use this information as a diagnostic tool to detect the specific conditions of a CMM?

A possible approach to the problem could be to observe how a parameter somehow connected to the performance of the machine varies over time (Oksman 1993, Reznik and Solopchenko 1985, Barbato and Franceschini 1994).

In particular, the idea that the authors propose is to consider as an indicator of the ‘normal’ conditions of the CMM its characteristic of reproducibility of the coordinates of a point carried out under changed path of measurements of the touch-probe subsystem (VIM 3.7).

The reproducibility of a CMM can be affected by different factors: the geometry of the part, the operating conditions of the machine subsystems, the aligning method for the reference system, the environmental conditions, and the positions of the considered measurement points in the operating volume of the machine.

Each element determines a part of the general variability that affects the characteristics of reproducibility. The possible drift of this indicator, from conditions considered ‘normal’, indicates the occurrence of a variation of one of the above listed factors (assignable causes). It does not, however, follow that a statistical test can identify which of the factors have changed.

If $\mathbf{P}^k(x, y, z)$ is the k th reproduction of the coordinates of a certain nominal point, namely $\mathbf{P}^1(x, y, z)$, carried out under changed path of measurements of the touch-probe subsystem, it is possible to define as the reproducibility of a CMM, the casual variable

$$R^{(k)} = d(\mathbf{P}^1, \mathbf{P}^k) \quad \forall k = 1, \dots, m \quad (1)$$

where $d(\mathbf{P}^1, \mathbf{P}^k)$ is the Euclidean distance operator between the reference point and its k th reproduction in the working volume. m is the number of reproductions carried out.

Taking into account the single contribution to the reproducibility, we can write

$$R^{(k)} = G^{(k)} + M^{(k)} + A^{(k)} + C^{(k)} + P^{(k)} \quad (2)$$

where $G^{(k)}$ represents the contribution to the variability determined by the part geometry, $M^{(k)}$ the contribution relevant to the CMM performances, $A^{(k)}$ the contribution of the reference system alignment on the part, $C^{(k)}$ the contribution of the environmental conditions, $P^{(k)}$ the contribution of the measurement point position in the working volume of the machine.

Under the hypotheses of independence of all variability sources, if $\sigma_{R^{(k)}}^2$ is the variance of $R^{(k)}$ for the k -th reproduction, the following equation holds:

$$\sigma_{R^{(k)}}^2 + \sigma_{G^{(k)}}^2 + \sigma_{M^{(k)}}^2 + \sigma_{A^{(k)}}^2 + \sigma_{C^{(k)}}^2 + \sigma_{P^{(k)}}^2 \quad (3)$$

similarly, for the expected value $\mu_{R^{(k)}}^2$ of $R^{(k)}$

$$\mu_{R^{(k)}} = \mu_{G^{(k)}} + \mu_{M^{(k)}} + \mu_{A^{(k)}} + \mu_{C^{(k)}} + \mu_{P^{(k)}} \quad (4)$$

For an ideal machine and for an ideal part, without any variability sources, we should have

$$\sigma_{R^{(k)}}^2 = 0 \text{ and } \mu_{R^{(k)}} = 0$$

In the practical applications $R^{(k)}$ is a distribution with an expected value $\mu_{R^{(k)}}$ and a variance $\sigma_{R^{(k)}}^2$ different from zero. These values depend on the type of machine, the part geometry and the reference operating conditions.

If during CMM operation, one or more of the introduced factors changes its contribution to the reproducibility characteristics, then the measurement process could not be any more able of yielding credible information.

A sufficient but not necessary condition that a CMM yields not credible measurements is that its reproducibility undergoes a variation from its own natural tolerance. The continuous observation of $R^{(k)}$ can therefore allow monitoring the performances of the whole machine/environment/part system with respect to suitable reference conditions.

Using control charts we are able to keep under control, at the same time, the central tendency and the dispersion of the casual variable $R^{(k)}$. From an operative point of view, if we have to measure a part whose measurement cycle is assigned, we can proceed as follows. If s is the total number of measurement points, a subset n is suitably selected, over which to carry out the reproducibility tests.

The frequency of verifications is established on the basis of the type of part to measure, the measurement costs and the control degree we intend to put into practice on the CMM performances. A simplified model for the computation of the frequency is presented at the end of the present section.

Information relevant to the reproducibility test is collected on $\bar{X} - \bar{R}$ control charts. Charts are used in

two distinct phases. In the first the control limits are identified; in the second the monitoring of the characteristic of reproducibility is performed.

The setting up of the charts occurs by considering m samples of the reproducibility tests carried out on the n selected points. The central values of the two control charts are obtained as follows:

$$\bar{R} = \frac{\sum_{i=1}^m R_i}{m}, \quad \bar{X} = \frac{\sum_{i=1}^m \bar{X}}{m} \quad (5)$$

While the upper and lower limits of the \bar{X} chart are determined, respectively, as

$$UCL_{\bar{X}} = \bar{X} + A_2 \cdot \bar{R} \quad LCL_{\bar{X}} = \bar{X} - A_2 \cdot \bar{R} \quad (6)$$

In the same way for the R chart

$$UCL_R = D_4 \cdot \bar{R} \quad LCL_R = D_3 \cdot \bar{R} \quad (7)$$

The parameters A_2 , D_3 , D_4 are tabulated for various values of the sample size n (Montgomery 1996).

Once the control charts have been built, the system monitoring starts. With a suitable frequency, along the normal measurement cycle, the reproducibility verification of the CMM is carried out. If points out-of-control or particular behaviors of the process parameters are observed, the anomaly is pointed out to the operator. The considerations and the criteria set on the charts in order to individuate out-of-control situations are totally applicable in this case (Montgomery 1996).

One of the aspects of the method that is worth further description is the frequency with which to repropose the reproducibility verifications. To establish the period p among two successive verifications (expressed in terms of number of measurement points – see figure 1) it can be useful to adopt the following simplified method.

C , the overall cost associated with the measurement process, can be thought of as composed by two terms, the first one proportional to the total measurement time, the second correlated to the effects of an unnoticed wrong measurement. The second term is approximately proportional to the period between two

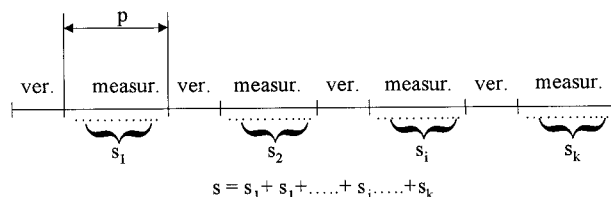

Figure 1. Sequence of measurement and verification activities inside the measurement cycle of a generic part. p is the period between a verification (ver.) and the successive. s is the set of points of the whole measurement cycle (measur.).

verifications (as the period increases, the probability that some part not correctly measured is to be remachined increases as well).

The total time T employed for the measurement of a new part is composed by two terms, the first correlated to the total number of points belonging to the measurement cycle, the second relevant to the time spent to carry out the reproducibility verifications.

$$T = st_p + \frac{s}{p}t_v \quad (8)$$

where t_p is the average measurement time of a point and t_v is the average time necessary to carry out a test (see figure 1).

The overall cost C can be formalized as follows:

$$C = c_1T + c_2p = c_1s \cdot \left(t_p + \frac{1}{p}t_v\right) + c_2p \quad (9)$$

c_1 is the cost of each measured point, and c_2 is the cost relevant to the execution of a wrong measurement. Figure 2 illustrates the behavior of C as a function of the frequency p . As can be observed, three distinct contributions are present, the first one (c_1st_p) constant, the second ($c_1s\frac{t_v}{p}$) decreasing as p increases, the third (c_2p) increasing with p .

A reasonable criterion, as a first attempt, to choose the test frequency can be that of minimizing the function C as p changes. In this way, we find

$$p^* = \sqrt{\frac{c_1st_v}{c_2}} \quad (10)$$

which clearly shows that the verification period p^* increases with s , t_v and the ratio c_1/c_2 , while it does not depend on t_p .

As far as the choice of the points on which to carry out the reproducibility verification is concerned, as a first attempt we can consider points sufficiently

distributed on the measurement volume of the part. To summarize, we recall the main characteristics of the proposed method:

- capability to operate during the normal operations of the CMM by carrying out a continuous estimation of the potential decay of its metrological performances.
- possibility to have continuous data with which to verify indirectly the conditions of the machine, without waiting for the execution of periodical verifications.
- possibility to operate without external reference artefacts (such as, for example, gauge blocks, ball-plate, etc.)
- economic and reliable technical solution.

From a strictly economic point of view the advantages of such an approach are manifest. With a relatively low cost solution, one can obtain an 'on-line' indication of the need of carrying out a periodic verification (see figure 3).

4. Experimental results

To closely investigate the proposed method a set of experimental tests has been carried out. The experimental activity was aimed to verify the real capability of the control charts to recognize anomalous operating conditions of the system, by means of the reproducibility tests.

The tests have been performed by the CMM (DEA model IOTA 0101 Standard motorized version) available in the laboratory of the Dipartimento di Sistemi di Produzione ed Economia dell'Azienda of the Politecni-

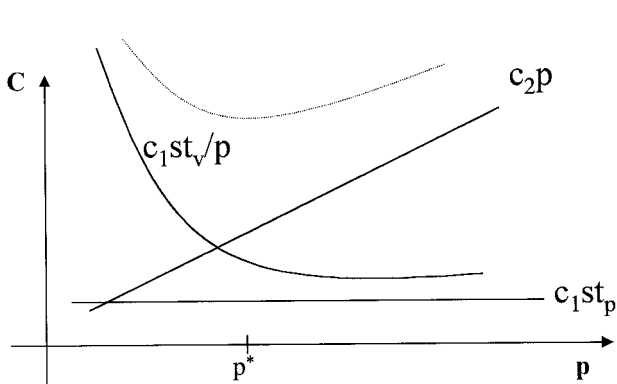

Figure 2. Total measurement cost and its components versus the period p of execution of the reproducibility tests. According to the model proposed, p^* represents the frequency minimizing the function C .

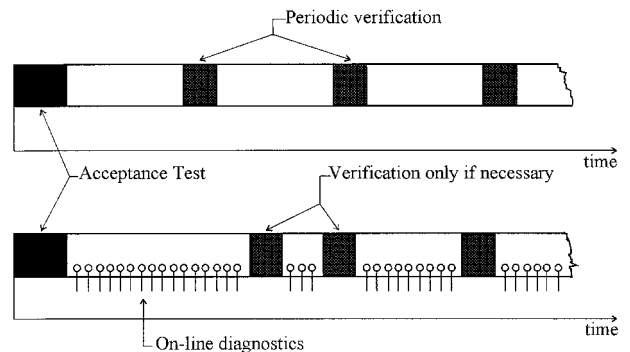

Figure 3. Time comparison of two distinct verification-strategies for a CMM. In the top part a periodic reverification is carried out (traditional procedure). In the bottom part an on-line monitoring verification is performed. The 'standard' verification process is triggered only when it is necessary.

co di Torino. The measuring machine has a moving bridge structure, with a measuring volume up to 555 mm in the X-axis, 610 mm in the Y-axis, and 410 mm in the Z-axis.

Figure 4 shows the geometrical and dimensional characteristics of the used parts. Workpieces have been obtained by a rapid prototyping machine using a photopolymeric epoxy resin with an average surface roughness of 0.02 mm and an average planarity error of 0.2 mm (Franceschini *et al.* 1994).

A measurement cycle of $s=60$ points has been programmed. The sample size n considered for the reproducibility verification has been $n=5$. The test frequency has been fixed every 20 measurement points ($p=20$ points). The first 5 points of the measurement cycle are those conventionally selected to perform the reproducibility tests.

To assist the experimental tests a software program has been realized. It allows the automatic alignment of the reference system and the storage of the coordinates of the measurement points of the cycle. To simulate the 'normal' operating conditions of a production line in a job-shop, the tests have been carried out without the use of the air-conditioning system (temperature and humidity controls). The CMM is used to inspect dimensions with large tolerances.

A first test has consisted in determining the natural variability of the process without assignable disturbance causes. Verifications have been carried out by maintaining the part in a fixed position in the measuring

volume of the CMM. Figures 5 and 6 show the results on $\bar{X} - R$ control charts.

For each measurement cycle three reproducibility tests have been carried out. The measurement cycle has been repeated 20 times, for a total of 60 tests. As can be observed, the variability is very limited around the central value (figure 5), while the average absolute value is quite high (about 0.03 mm). This value must be attributed to the particular material and to the finish of the surfaces of the workpieces. The central value, however, is not relevant from the diagnostics point of view, while its variations over time are relevant.

As far as the R chart is concerned, analogous considerations can be drawn, with respect to the ones drawn for the \bar{X} chart (see figure 6).

Figures 7 and 8 simulate the inspection of 20 workpieces. They illustrate the sequence of activities normally developed during a measurement process of a part in a production line:

- (a) place workpiece within the measuring volume of the CMM (part positioning)
- (b) set up the coordinate system for the workpiece (reference system alignment)
- (c) measure each feature of the workpiece (measurement cycle execution)
- (d) remove the workpiece from the CMM (part removing)
- (e) introduction of a new part in the measuring volume and so on.

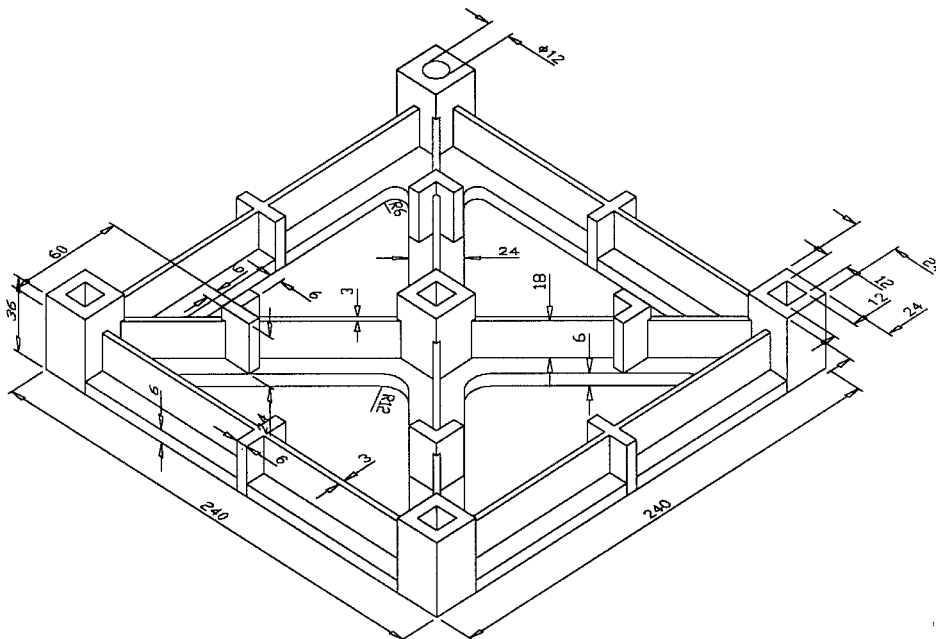

Figure 4. Geometrical characteristics (values in mm) of the part used for the experimentation (Franceschini *et al.* 1994).

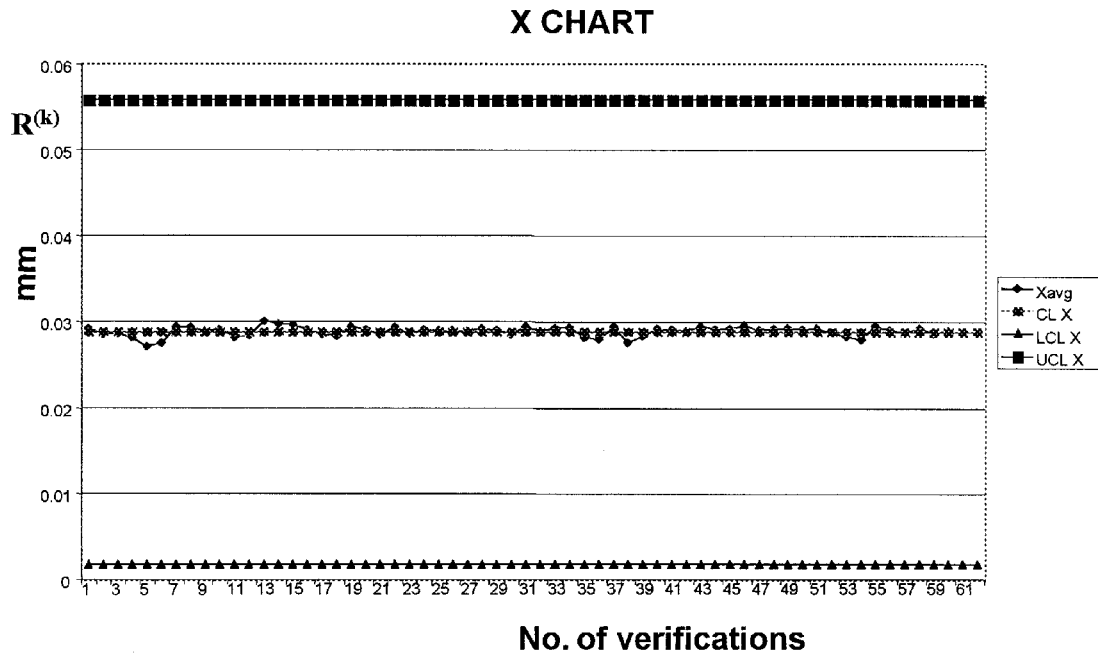

Figure 5. \bar{X} -chart of the reproducibility tests carried out after the alignment of the reference system to the measured part (see figure 4), keeping unchanged all the potential affecting factors. The process is under control conditions. The control chart limits are determined on the basis of the first 20 samples. For each measurement cycle three tests have been carried out.

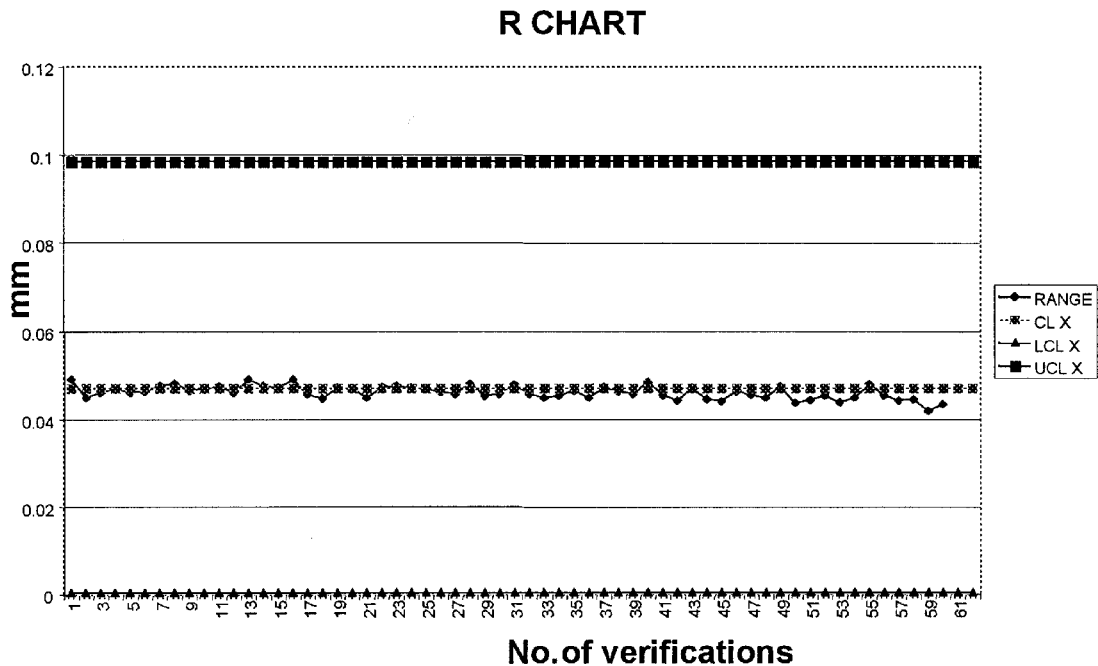

Figure 6. R chart of the reproducibility tests carried out after the alignment of the reference system to the measured part (see figure 4), keeping unchanged all the potential affecting factors. The process is under control limit. The limits of the control chart have been determined on the basis of the first 20 samples. For each measurement cycle three reproducibility tests have been carried out.

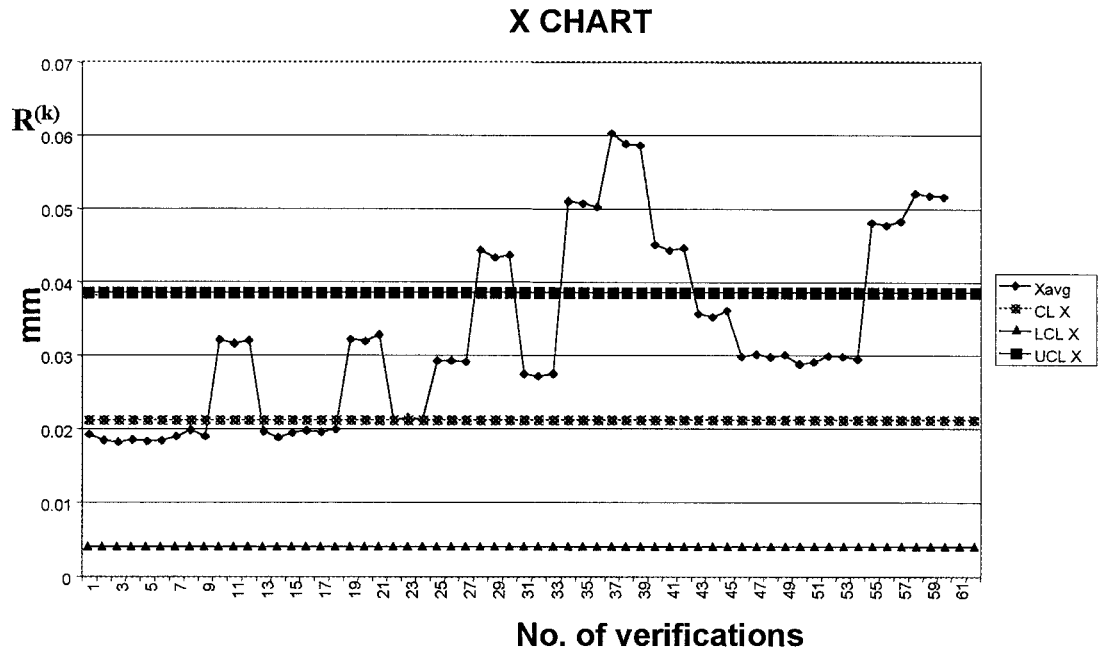

Figure 7. \bar{X} -chart of the reproducibility tests obtained by carrying out the positioning and measurement of several successive parts. The observed discontinuities reveal the effects of the introduced variability. For each measurement cycle three reproducibility tests have been carried out.

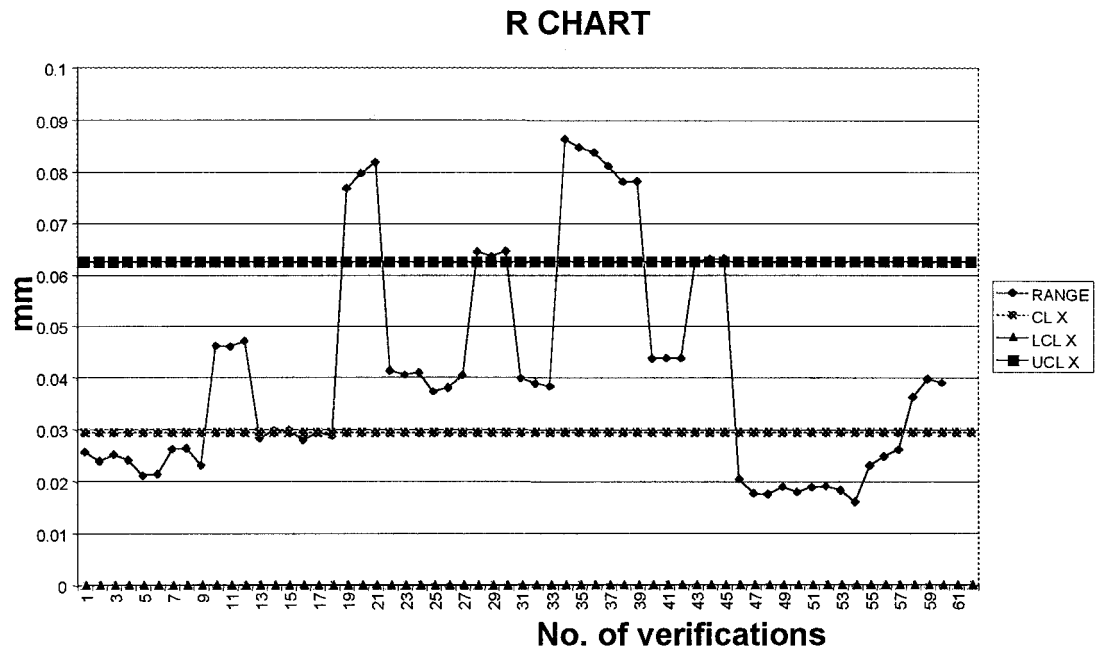

Figure 8. R chart of the reproducibility tests obtained by carrying out the positioning and measurement of several successive parts. The observed discontinuities reveal the effects of the introduced variability. For each measurement cycle three reproducibility tests have been carried out.

The reproducibility test has been also carried out with a frequency of three verifications for each measurement cycle. The obtained results show the

variability contribution determined by the workpiece positioning factor and by the consequent aligning of the reference system. The triples of points observed are

relevant to the three reproducibility tests associated with each measurement cycle.

The high values in the chart of range are due to the fact that $R^{(k)}$ is calculated with reference to the first touched-point $\mathbf{P}^1(x, y, z)$ in the first reproducibility test (see (1)). These absolute values are not relevant from the diagnostics point of view, but their variations over time are relevant.

The proposed method can also be 'enriched' by an automated measurement of some points of a 'witness-part' external to the measured part, but within the machine envelope. The use of a witness-part relies on a specialization of diagnostics. In particular, it allows an allocation of the total variability among each single component (see (2)). Moreover, additional external 'reference points' can be included, at the beginning of a measurement cycle, to discriminate between machine sub-system performances and the natural variation of machined parts (form and 'positional').

A last observation to be made is on the values assumed by $R^{(k)}$ in the R chart. They are correlated to the variability derived from the contact modalities of the test points inside the working volume of the CMM.

5. Conclusion and future developments

The user of a coordinate measuring machine in a production line is usually interested in the setting up of rapid and effective tools that are able to verify the maintenance of the performance specifications of a CMM that have been guaranteed at the moment of the acceptance tests. The possibility of on-line evaluation of the decay of the metrological characteristics of a CMM due, for example, to the variations of the environmental factors or to a damage of some components is, therefore, an activity of evident interest.

The paper has presented a method, based on the use of control charts, that is able to verify and recognize some anomaly working conditions of the machine/environment/part system. It is shown that the chart based on the reproducibility of the coordinates of a point carried out under a changed path of measurements of the touch-probe subsystem is influenced by variations of the working conditions of a CMM. This makes the method particularly suitable to be used with a CMM inserted in operating contexts such as job-shops or automated production lines.

The on-line use of $R^{(k)}$ determines, as an immediate consequence, an increase of the time necessary to the execution of the measurement cycle of a part. Such a disadvantage represents the counterpart to the possibility of on-line evaluation of the reliability of the collected measurements.

In order not to increase the cycle-time too much, it is possible to limit the verification of $R^{(k)}$ to a reduced number of points. The choice of the sample points and of the test frequency is crucial. The results of the experimental activity represent only a preliminary answer to the problem of defining methodologies to give real-time indications of the performance level of a CMM. They constitute a first achievement for the user in an optic of production quality.

For the future, there will be an in-depth study aimed at exploring the possibilities of discriminating the effects produced by the single influence factors.

Acknowledgements

The authors would like to thank anonymous referees for their helpful comments and suggestions.

References

- AFNOR NF E 11-150, 1986, *Machine à mesurer*.
- ALEXANDER, S.M., LEE, W.Y., and GRAHAM, J.T., 1993, Design-based diagnosis. *International Journal of Production Research*, **31**, 2087–2096.
- ANSI/ASME B89.1.12M, 1990, *Methods for performance evaluation of coordinate measuring machines*.
- BARBATO, G., and FRANCESCHINI, F., 1994, Performance indicators for multicomponent dynamometers. *Measurement*, **13**, 297–306.
- BELFORTE, G., BONA, B., CANUTO, E., DONATI, F., FERRARIS, F., GORINI, I., MOREI, S., PEISINO, M., and SARTORI, S., 1987, Coordinate measuring machines and machine tools self-calibration and error correction. *Annals of the CIRP*, **36**, 359–364.
- BSI 6808, 1987, *Coordinate measuring machines*.
- BUSCH, K., KUNZMANN, H., and WALDELE, F., 1985, Calibration of coordinate measuring machines. *Precision Engineering*, **7**, 139–144.
- CMMA, 1989, *Accuracy specification for coordinate measuring machines*.
- FRANCESCHINI, F., IULIANO, L., and ROMANO, D., 1994, Conoscenza a priori per la diagnostica in linea su macchine di misura. *Automazione & Strumentazione*, XLII, 87–91.
- FRANCESCHINI, F., and LUISONI, M., 1995, Qualità nella produzione e prestazioni delle CMM: uno strumento di supporto alla diagnostica in linea basato sulla credibilità delle misure. *Qualità*, XXV, (3), 46–49, (4), 47–55.
- FRANCESCHINI, F., IULIANO, L., and IPPOLITO, R., 1994, Valutazione Multicriteri di tecniche di Rapid Prototyping con il metodo Analytic Hierarchy Process (AHP). *First Conference on Artificial Intelligence Techniques in Engineering*, pp. 225–236.
- ISO 10012-1, 1992, *Quality assurance requirements for measuring equipment*.
- ISO 10360, 1995, *Coordinate metrology*.
- KNAPP, W., TSCHDI, and BUCHER, 1991, Comparison of different artifacts for interim coordinate measuring machine checking: a report from the Swiss standards Committee. *Precision Engineering*, **13**, 277.

- OKSMAN, J., 1993, Définition et obtention en temps réel de la crédibilité d'une mesure. *6e Congrès International de Metrologie*, Lille, pp. 224–229.
- MONTGOMERY, D.C., 1996, *Introduction to Statistical Quality Control* (New York: Wiley).
- PAU, L.F., 1981, *Failure diagnosis and performance monitoring* (New York: Marcel Dekker).
- RAZ, T., and LADANY, S.P., 1992, Optimal policy for imperfect inspection in discrete time. *Production Planning & Control*, **3**, 48–56.
- REZNIK, L.K., and SOLOPCHENKO, G.N., 1985, Use of a priori information on functional relations between measured quantities for improving accuracy of measurement. *Measurement*, **3**, 98–106.
- VIM, 1993, *International vocabulary of basic and general terms in metrology*, ISO, Geneva.
- ISO/IEC/OIML/BIPM/IUPAC/IUPAP, 1993, *Guide to the Expression of Uncertainty in Measurement*.